

INSTRUCTION MANUAL

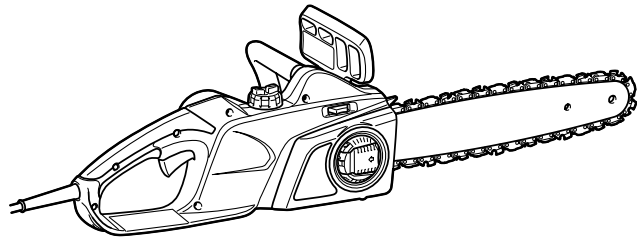

# Electric Chain Saw

UC3041A  
UC3541A  
UC4041A



014315



DOUBLE INSULATION

**IMPORTANT:** Read Before Using.

ENGLISH (Original instructions)

**SPECIFICATIONS**

Model		UC3041A		UC3541A		UC4041A	
Max. chain speed		14.5 m/s (870 m/min)					
Standard guide bar	Bar length	300 mm		350 mm		400 mm	
	Cutting length	265 mm		325 mm		360 mm	
	Guide bar type	Sprocket nose bar					
Standard saw chain	Type	90PX	91PX	90PX	91PX	90PX	91PX
	Pitch	3/8"					
	No. of drive links	46		52		56	
Recommended guide bar length		300 - 400 mm					
Overall length (without guide bar)		455 mm					
Net weight		4.6 kg		4.7 kg		4.7 kg	
Extension cable (optional)		DIN 57282/HO 7RN -F L=30 m max.,3x1.5 mm <sup>2</sup>					

- Due to our continuing program of research and development, the specifications herein are subject to change without notice.
- Specifications may differ from country to country.
- Weight according to EPTA-Procedure 01/2003

END218-7

**Symbol**

The following show the symbols used for the equipment. Be sure that you understand their meaning before use.

- Read instruction manual and follow the warnings and safety instructions.
- Wear eye protection.
- Wear ear protection.
- DOUBLE INSULATION
- Caution: particular care and attention required!
- Caution: withdraw the mains plug immediately if the cable is damaged!
- Caution: kickback!
- Protect against rain and damp!
- Wear a helmet, goggles and ear protection!
- Wear safety gloves!
- Withdraw the mains plug!
- First aid
- Maximum permissible length of cut
- Direction of chain travel
- Chain oil



· Chain brake released



· Chain brake applied



· Prohibited!



· Only for EU countries

Do not dispose of electric equipment together with household waste material!

In observance of the European Directive, on Waste Electric and Electronic Equipment and its implementation in accordance with national law, electric equipment that have reached the end of their life must be collected separately and returned to an environmentally compatible recycling facility.

ENE085-1

**Intended use**

The tool is intended for cutting lumbers and logs.

ENF002-2

**Power supply**

The tool should be connected only to a power supply of the same voltage as indicated on the nameplate, and can only be operated on single-phase AC supply. They are double-insulated and can, therefore, also be used from sockets without earth wire.

ENF100-1

**For public low-voltage distribution systems of between 220 V and 250 V.**

Switching operations of electric apparatus cause voltage fluctuations. The operation of this device under unfavorable mains conditions can have adverse effects

to the operation of other equipment. With a mains impedance equal or less than 0.29 Ohms it can be presumed that there will be no negative effects. The mains socket used for this device must be protected with a fuse or protective circuit breaker having slow tripping characteristics.

ENG905-1

### Noise

The typical A-weighted noise level determined according to EN60745:

Sound pressure level ( $L_{pA}$ ) : 90.3 dB (A)

Sound power level ( $L_{WA}$ ) : 101.3 dB (A)

Uncertainty (K) : 2.5 dB (A)

### Wear ear protection

ENG900-1

### Vibration

The vibration total value (tri-axial vector sum) determined according to EN60745:

Work mode : cutting wood

Vibration emission ( $a_h$ ) : 4.7 m/s<sup>2</sup>

Uncertainty (K) : 1.5 m/s<sup>2</sup>

ENG901-1

- The declared vibration emission value has been measured in accordance with the standard test method and may be used for comparing one tool with another.
- The declared vibration emission value may also be used in a preliminary assessment of exposure.

### WARNING:

- The vibration emission during actual use of the power tool can differ from the declared emission value depending on the ways in which the tool is used.
- Be sure to identify safety measures to protect the operator that are based on an estimation of exposure in the actual conditions of use (taking account of all parts of the operating cycle such as the times when the tool is switched off and when it is running idle in addition to the trigger time).

### For European countries only

### EC Declaration of Conformity

#### Makita declares that the following Machine(s):

Designation of Machine:

Chain Saw

Model No./ Type: UC3041A, UC3541A, UC4041A

Specifications: see "SPECIFICATIONS" table.

#### Conforms to the following European Directives:

2000/14/EC, 2006/42/EC

They are manufactured in accordance with the following Standard or standardized documents:

EN60745

The Technical file in accordance with 2006/42/EC is available from:

Makita, Jan-Baptist Vinkstraat 2, 3070, Belgium

The conformity assessment procedure required by Directive 2000/14/EC was in Accordance with annex V

Measured Sound Power Level: 102.2 dB (A)

Guaranteed Sound Power Level: 104 dB (A)

26.4.2013



000331

Yasushi Fukaya  
Director

Makita, Jan-Baptist Vinkstraat 2, 3070, Belgium

GEA005-3

## General Power Tool Safety Warnings

 **WARNING** Read all safety warnings and all instructions. Failure to follow the warnings and instructions may result in electric shock, fire and/or serious injury.

## Save all warnings and instructions for future reference.

The term "power tool" in the warnings refers to your mains-operated (corded) power tool or battery-operated (cordless) power tool.

### Work area safety

1. **Keep work area clean and well lit.** Cluttered or dark areas invite accidents.
2. **Do not operate power tools in explosive atmospheres, such as in the presence of flammable liquids, gases or dust.** Power tools create sparks which may ignite the dust or fumes.

3. **Keep children and bystanders away while operating a power tool.** Distractions can cause you to lose control.

#### Electrical safety

4. **Power tool plugs must match the outlet. Never modify the plug in any way. Do not use any adapter plugs with earthed (grounded) power tools.** Unmodified plugs and matching outlets will reduce risk of electric shock.
5. **Avoid body contact with earthed or grounded surfaces such as pipes, radiators, ranges and refrigerators.** There is an increased risk of electric shock if your body is earthed or grounded.
6. **Do not expose power tools to rain or wet conditions.** Water entering a power tool will increase the risk of electric shock.
7. **Do not abuse the cord. Never use the cord for carrying, pulling or unplugging the power tool. Keep cord away from heat, oil, sharp edges or moving parts.** Damaged or entangled cords increase the risk of electric shock.
8. **When operating a power tool outdoors, use an extension cord suitable for outdoor use.** Use of a cord suitable for outdoor use reduces the risk of electric shock.
9. **If operating a power tool in a damp location is unavoidable, use a residual current device (RCD) protected supply.** Use of an RCD reduces the risk of electric shock.
10. **Use of power supply via a RCD with a rated residual current of 30mA or less is always recommended.**

#### Personal safety

11. **Stay alert, watch what you are doing and use common sense when operating a power tool. Do not use a power tool while you are tired or under the influence of drugs, alcohol or medication.** A moment of inattention while operating power tools may result in serious personal injury.
12. **Use personal protective equipment. Always wear eye protection.** Protective equipment such as dust mask, non-skid safety shoes, hard hat, or hearing protection used for appropriate conditions will reduce personal injuries.
13. **Prevent unintentional starting. Ensure the switch is in the off-position before connecting to power source and/or battery pack, picking up or carrying the tool.** Carrying power tools with your finger on the switch or energising power tools that have the switch on invites accidents.
14. **Remove any adjusting key or wrench before turning the power tool on.** A wrench or a key left attached to a rotating part of the power tool may result in personal injury.

15. **Do not overreach. Keep proper footing and balance at all times.** This enables better control of the power tool in unexpected situations.
16. **Dress properly. Do not wear loose clothing or jewellery. Keep your hair, clothing, and gloves away from moving parts.** Loose clothes, jewellery or long hair can be caught in moving parts.
17. **If devices are provided for the connection of dust extraction and collection facilities, ensure these are connected and properly used.** Use of dust collection can reduce dust-related hazards.

#### Power tool use and care

18. **Do not force the power tool. Use the correct power tool for your application.** The correct power tool will do the job better and safer at the rate for which it was designed.
19. **Do not use the power tool if the switch does not turn it on and off.** Any power tool that cannot be controlled with the switch is dangerous and must be repaired.
20. **Disconnect the plug from the power source and/or the battery pack from the power tool before making any adjustments, changing accessories, or storing power tools.** Such preventive safety measures reduce the risk of starting the power tool accidentally.
21. **Store idle power tools out of the reach of children and do not allow persons unfamiliar with the power tool or these instructions to operate the power tool.** Power tools are dangerous in the hands of untrained users.
22. **Maintain power tools. Check for misalignment or binding of moving parts, breakage of parts and any other condition that may affect the power tool's operation. If damaged, have the power tool repaired before use.** Many accidents are caused by poorly maintained power tools.
23. **Keep cutting tools sharp and clean.** Properly maintained cutting tools with sharp cutting edges are less likely to bind and are easier to control.
24. **Use the power tool, accessories and tool bits etc. in accordance with these instructions, taking into account the working conditions and the work to be performed.** Use of the power tool for operations different from those intended could result in a hazardous situation.

#### Service

25. **Have your power tool serviced by a qualified repair person using only identical replacement parts.** This will ensure that the safety of the power tool is maintained.
26. **Follow instruction for lubricating and changing accessories.**
27. **Keep handles dry, clean and free from oil and grease.**

## Chain saw safety warnings

1. **Keep all parts of the body away from the saw chain when the chain saw is operating. Before you start the chain saw, make sure the saw chain is not contacting anything.** A moment of inattention while operating chain saws may cause entanglement of your clothing or body with the saw chain.
2. **Always hold the chain saw with your right hand on the rear handle and your left hand on the front handle.** Holding the chain saw with a reversed hand configuration increases the risk of personal injury and should never be done.
3. **Hold the power tool by insulated gripping surfaces only, because the saw chain may contact hidden wiring or its own cord.** Saw chains contacting a "live" wire may make exposed metal parts of the power tool "live" and could give the operator an electric shock.
4. **Wear safety glasses and hearing protection. Further protective equipment for head, hands, legs and feet is recommended.** Adequate protective clothing will reduce personal injury by flying debris or accidental contact with the saw chain.
5. **Do not operate a chain saw in a tree.** Operation of a chain saw while up in a tree may result in personal injury.
6. **Always keep proper footing and operate the chain saw only when standing on fixed, secure and level surface.** Slippery or unstable surfaces such as ladders may cause a loss of balance or control of the chain saw.
7. **When cutting a limb that is under tension be alert for spring back.** When the tension in the wood fibres is released the spring loaded limb may strike the operator and/or throw the chain saw out of control.
8. **Use extreme caution when cutting brush and saplings.** The slender material may catch the saw chain and be whipped toward you or pull you off balance.
9. **Carry the chain saw by the front handle with the chain saw switched off and away from your body. When transporting or storing the chain saw always fit the guide bar cover.** Proper handling of the chain saw will reduce the likelihood of accidental contact with the moving saw chain.
10. **Follow instructions for lubricating, chain tensioning and changing accessories.** Improperly tensioned or lubricated chain may either break or increase the chance for kickback.
11. **Keep handles dry, clean, and free from oil and grease.** Greasy, oily handles are slippery causing loss of control.
12. **Cut wood only. Do not use chain saw for purposes not intended. For example: do not use chain saw for cutting plastic, masonry or non-wood building materials.** Use of the chain saw for operations different than intended could result in a hazardous situation.
13. **Causes and operator prevention of kickback:**  
 Kickback may occur when the nose or tip of the guide bar touches an object, or when the wood closes in and pinches the saw chain in the cut. Tip contact in some cases may cause a sudden reverse reaction, kicking the guide bar up and back towards the operator.  
 Pinching the saw chain along the top of the guide bar may push the guide bar rapidly back towards the operator.  
 Either of these reactions may cause you to lose control of the saw which could result in serious personal injury. Do not rely exclusively upon the safety devices built into your saw. As a chain saw user, you should take several steps to keep your cutting jobs free from accident or injury. Kickback is the result of tool misuse and/or incorrect operating procedures or conditions and can be avoided by taking proper precautions as given below:
  - **Maintain a firm grip, with thumbs and fingers encircling the chain saw handles, with both hands on the saw and position your body and arm to allow you to resist kickback forces.** Kickback forces can be controlled by the operator, if proper precautions are taken. Do not let go of the chain saw.

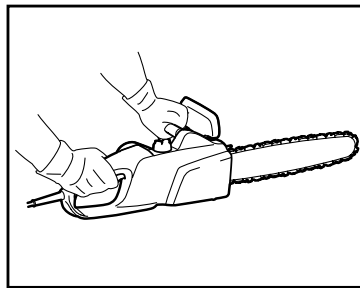

014316

- **Do not overreach and do not cut above shoulder height.** This helps prevent unintended tip contact and enables better control of the chain saw in unexpected situations.
- **Only use replacement bars and chains specified by the manufacturer.** Incorrect replacement bars and chains may cause chain breakage and/or kickback.

- **Follow the manufacturer's sharpening and maintenance instructions for the saw chain.** Decreasing the depth gauge height can lead to increased kickback.

## ADDITIONAL SAFETY RULES

1. Read the instruction manual in order to familiarize yourself with operation of the chain saw.
2. Before using the chain saw for the first time, arrange to have instruction in its operation. If this is not possible, at least practice cutting round timber on a trestle before beginning work.
3. The chain saw must not be used by children or young persons under 18 years of age. Young persons over 16 years of age may be exempted from this restriction if they are undergoing training under the supervision of an expert.
4. Working with the chain saw requires a high level of concentration. Do not work with the saw if you are not feeling fit and well. Carry out all work calmly and carefully.
5. Never work under the influence of alcohol, drugs or medication.

### Proper use

1. The chain saw is intended solely for cutting wood. Do not use it for example to cut plastic or porous concrete.
2. Only use the chain saw for operations described in this instruction manual. Do **not**, for example, use it to trim hedges or for similar purposes.
3. The chain saw must not be used for forestry work, i.e. for felling and limbing standing timber. The chain saw cable does not provide the operator with the mobility and safety required for such work.
4. The chain saw is not intended for commercial use.
5. Do not overload the chain saw.

### Personal protective equipment

1. Clothing must be close-fitting, but must not obstruct mobility.
2. Wear the following protective clothing during work:
  - A tested safety helmet, if a hazard is presented by falling branches or similar;
  - A face mask or goggles;
  - Suitable ear protection (ear muffs, custom or mouldable ear plugs). Octave band analysis upon request.
  - Firm leather safety gloves;
  - Long trousers manufactured from strong fabric;
  - Protective dungarees of cut-resistant fabric;
  - Safety shoes or boots with non-slip soles, steel toes, and cut-resistant fabric lining;

- A breathing mask, when carrying out work which produces dust (e.g. sawing dry wood).

### Protection against electric shock



- The chain saw must not be used in wet weather or damp environments, as the electric motor is not waterproof.
1. Only plug the saw into sockets in tested electrical circuits. Check that the system voltage matches that on the rating plate. Ensure that a 16 A line fuse is fitted. Saws used in the open air must be connected to a residual current-operated circuit-breaker with an operating current no higher than 30 mA.



- Should the connecting cable be damaged, withdraw the mains plug immediately.

### Safe working practices

1. Before starting work, check that the chain saw is in proper working order and that its condition complies with the safety regulations. Check in particular that:
  - The chain brake is working properly;
  - The run-down brake is working properly;
  - The bar and the sprocket cover are fitted correctly;
  - The chain has been sharpened and tensioned in accordance with the regulations;
  - The mains cable and mains plug are undamaged;

Refer to the "CHECKS " section.

2. Always ensure in particular that the extension cable used is of adequate cross-section (see "SPECIFICATIONS"). When using a cable reel, wind the cable completely off the reel. When using the saw in the open air, ensure that the cable employed is intended for open-air use and is rated accordingly.
3. Keep the cord away from the cutting area and to position cord so that it will not be caught on branches, and the like, during cutting.
4. Do not operate the chain saw in the vicinity of flammable dust or gases, as the motor generates sparks and presents **a risk of explosion**.
5. Work only on firm ground and with a good footing. Pay particular attention to obstacles (e.g. the cable) in the working area. Take particular care where moisture, ice, snow, freshly cut wood or bark may make surfaces slippery. Do not stand on ladders or trees when using the saw.
6. Take particular care when working on sloping ground; rolling trunks and branches pose a potential hazard.
7. Never cut above shoulder height.



8. **Hold the chain saw with both hands when switching it on and using it.** Hold the rear handle with your right hand and the front handle with your left. Hold the handles firmly with your thumbs. The bar and the chain must not be in contact with any objects when the saw is switched on.

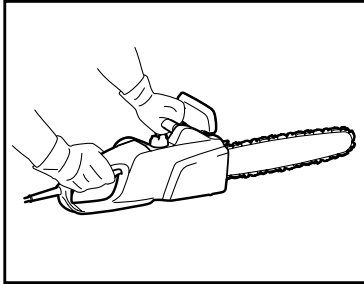

014316

9. Clean the area to be cut of foreign objects such as sand, stones, nails, wire, etc. Foreign objects damage the bar and chain, and can lead to dangerous kickback.
10. Take particular care when cutting in the vicinity of wire fences. Do not cut into the fence, as the saw may kick back.
11. Do not cut into the ground.
12. Cut pieces of wood singly, not in bunches or stacks.
13. Avoid using the saw to cut thin branches and roots, as these can become entangled in the chain saw. Loss of balance presents a hazard.
14. Use a secure support (trestle) when cutting sawn timber.
15. Do not use the chain saw to prise off or brush away pieces of wood and other objects.
16. Guide the chain saw such that no part of your body is within the extended path of the saw chain (see figure).

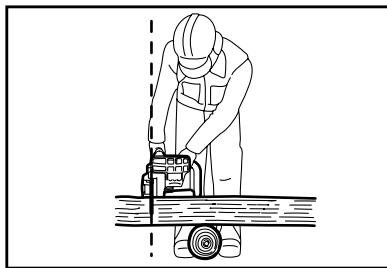

006909

17. When moving around between sawing operations, apply the chain brake in order to prevent the chain from being operated unintentionally. Hold the chain saw by the front handle when carrying it, and do not keep your finger on the switch.
18. Withdraw the mains plug when taking breaks or leaving the chain saw unattended. Leave the chain saw where it cannot present a hazard.

## Kickback

1. Hazardous kickback may arise during work with the chain saw. Kickback arises when the tip of the bar (in particular the upper quarter) comes into contact with wood or another solid object. This causes the chainsaw to be deflected in the direction of the operator.

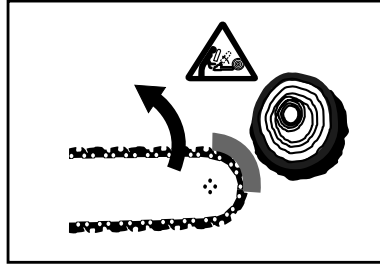

006919

2. In order to avoid kickback, observe the following:
  - Never begin the cut with the tip of the bar.
  - Never use the tip of the bar for cutting. Take particular care when resuming cuts which have already been started.
  - Start the cut with the chain running.
  - Always sharpen the chain correctly. In particular, set the depth gauge to the correct height.
  - Never saw through several branches at a time.
  - When limbing, take care to prevent the bar from coming into contact with other branches.
  - When bucking, keep clear of adjacent trunks. Always observe the bar tip.
  - Use a trestle.

## Safety features

1. Always check that the safety features are in working order before starting work. Do not use the chain saw if the safety features are not working properly.
  - **Chain brake:**  
The chain saw is fitted with a chain brake which brings the saw chain to a standstill within a fraction of a second. It is activated when the hand guard is pushed forwards. The saw chain then stops within 0.15 s, and the power supply to the motor is interrupted.

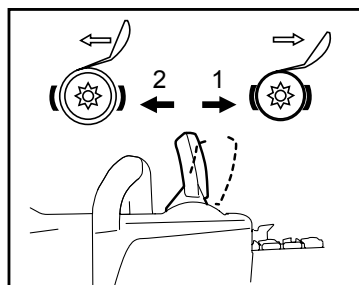

014317

1. Chain brake applied
2. Chain brake released

#### - **Run-down brake:**

The chain saw is equipped with an run down brake which brings the saw chain to an immediate stop when the ON/OFF switch is released. This prevents the saw chain from running on when switched off, and thus presenting a hazard.

- The **front and rear hand guards** protect the user against injury from pieces of wood which may be thrown backwards, or a broken saw chain.
- The **trigger lockout** prevents the chain saw from being switched on accidentally.
- The **chain catcher** protects the user against injury should the chain jump or break.

### Transport and storage



- When the chain saw is not in use or is being transported, withdraw the mains plug and fit the guide bar cover supplied with the saw. Never carry or transport the saw with the saw chain running.
1. Carry the chain saw by the front handle only, with the bar pointing backwards.
  2. Keep the chain saw in a secure, dry and locked room out of the reach of children. Do not store the chain saw outdoors.

### Maintenance

1. Withdraw the plug from the socket before carrying out any adjustments or maintenance.
2. Check the power cable regularly for damage to the insulation.
3. Clean the chain saw regularly.
4. Have any damage to the plastic housing repaired properly and immediately.
5. Do not use the saw if the switch trigger is not working properly. Have it properly repaired.
6. Under no circumstances should any modifications be made to the chain saw. Your safety is at risk.
7. Do not carry out maintenance or repair work other than that described in this instruction manual. Any other work must be carried out by authorized service centers.
8. Only use genuine replacement parts and accessories intended for your model of saw. The use of other parts increases the risk of accident.
9. We accept no responsibility for accidents or damage should non-approved bars, saw chains or other replacement parts or accessories be used.

### First aid



- Do not work alone. Always work within shouting distance of a second person.
1. Always keep a first-aid box to hand. Replace any items taken from it immediately.
  2. Should you request assistance in the event of an accident, state the following:
    - Where did the accident happen?
    - What happened?
    - How many persons are injured?
    - What injuries do they have?
    - Who is reporting the accident?

### NOTE:

Individuals with poor circulation who are exposed to excessive vibration may experience injury to blood vessels or the nervous system.

Vibration may cause the following symptoms to occur in the fingers, hands or wrists: "Falling asleep" (numbness), tingling, pain, stabbing sensation, alteration of skin colour or of the skin.

**If any of these symptoms occur, see a physician!**

## SAVE THESE INSTRUCTIONS.

### **WARNING:**

**DO NOT let comfort or familiarity with product (gained from repeated use) replace strict adherence to safety rules for the subject product. MISUSE or failure to follow the safety rules stated in this instruction manual may cause serious personal injury.**



## DESIGNATION OF PARTS

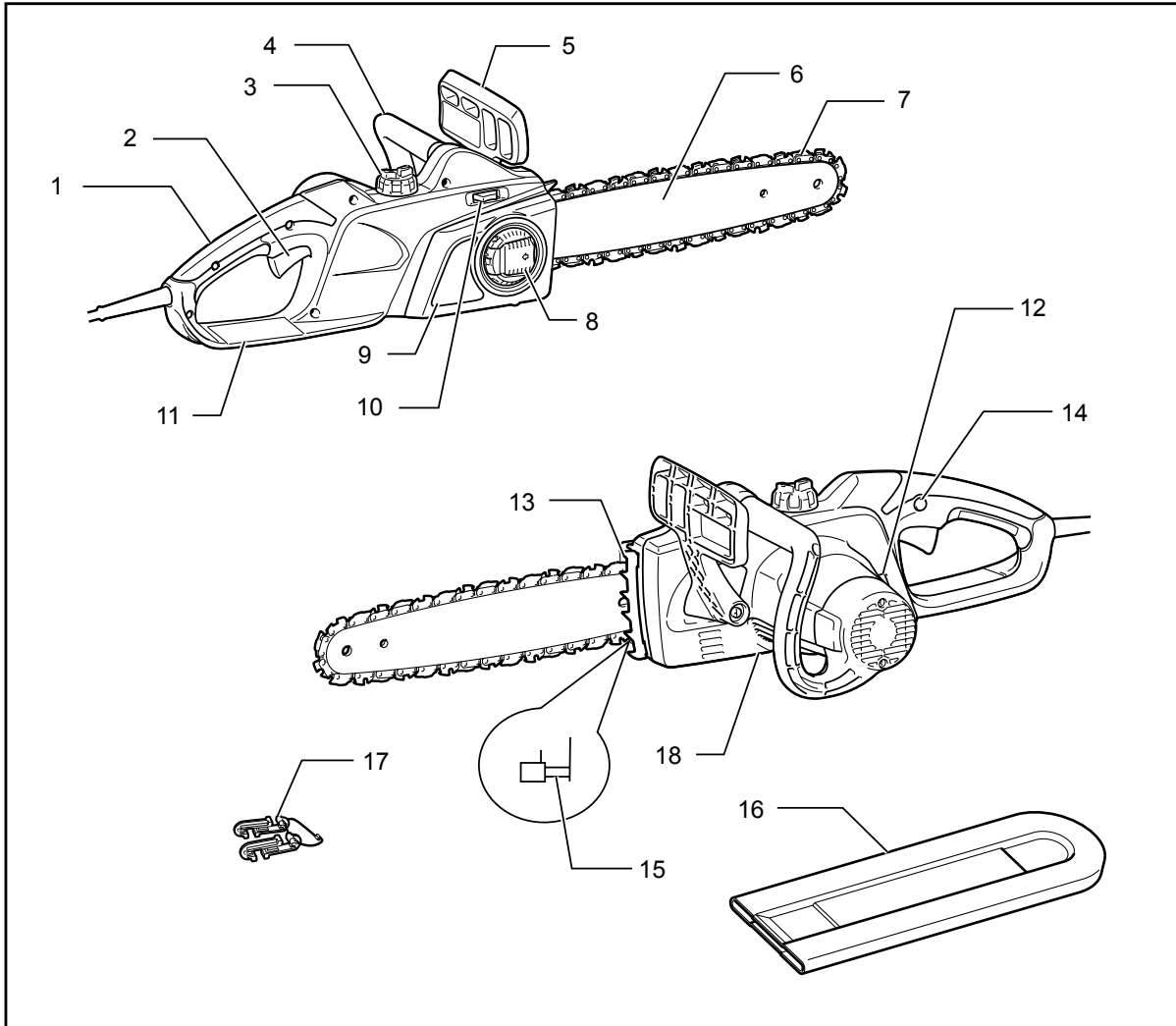

014318

1	Rear handle	7	Saw chain	13	Spike bumper
2	Switch trigger	8	Lever	14	Lock-off button
3	Oil filler cap	9	Sprocket cover	15	Chain catcher
4	Front handle	10	Adjusting dial	16	Guide bar cover
5	Front hand guard	11	Rear hand guard	17	Cord hook
6	Guide bar	12	Oil level sight	18	Adjusting screw for oil pump (at the bottom)

014319

# ASSEMBLY

## ⚠ CAUTION:

- Always be sure that the tool is switched off and unplugged before carrying out any work on the tool.

## Removing or installing saw chain

## ⚠ CAUTION:

- Always wear gloves when installing or removing the saw chain.

To remove the saw chain, perform the following steps:

- Press and fully open the lever until it stops.

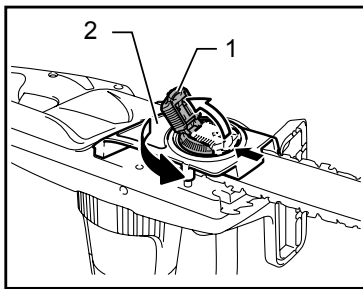

- Lever
- Sprocket cover

014342

- Turn the lever counterclockwise to loosen the sprocket cover until it comes off.
- Turn the adjusting dial to "-" direction to release the saw chain tension.

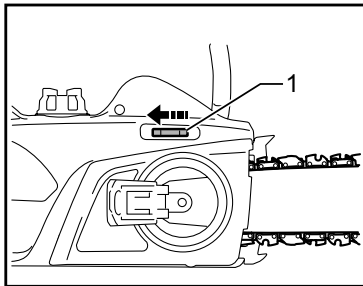

- Adjusting dial

014324

- Remove the sprocket cover.
- Remove the saw chain and guide bar from the chain saw.

To install the saw chain, perform the following steps:

- Make sure the direction of the chain. The arrow mark on the chain shows the direction of the chain.

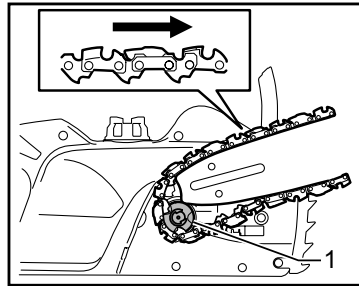

- Sprocket

014323

- Fit in one end of the saw chain on the top of the guide bar and the other end of it around the sprocket.
- Rest the guide bar in place on the chain saw.
- Align the tension slide with the hole of the guide bar.

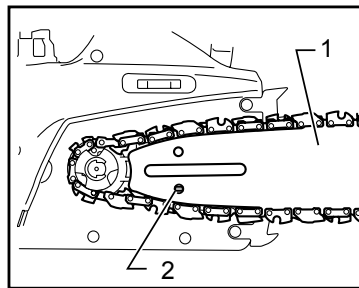

- Guide bar
- Hole

014422

- Holding the guide bar, and turn the adjusting dial to "+" direction to adjust the saw chain tension.
- Place the sprocket cover so that the hooks fit alongside the holes and the pin fits its counterpart on the sprocket cover.

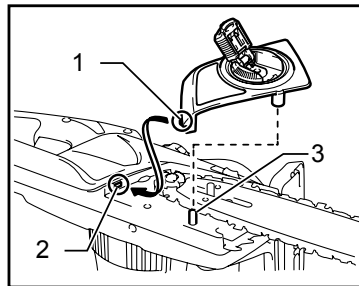

- Hook
- Hole
- Pin

014325

- Turn the lever clockwise to secure the sprocket cover.

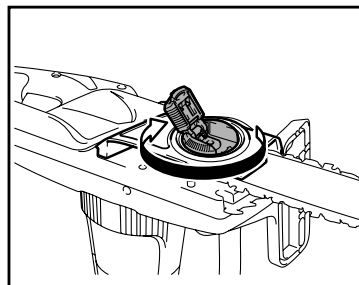

014326

- Press and return the lever to its original position.

## Adjusting saw chain tension

The saw chain may become loose after many hours of use. From time to time check the saw chain tension before use.

1. Press and fully open the lever until it clicks. Turn it counterclockwise a little to loosen sprocket cover lightly.

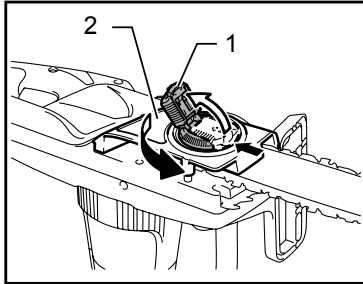

1. Lever
2. Sprocket cover

014342

2. Lift up the guide bar tip slightly.

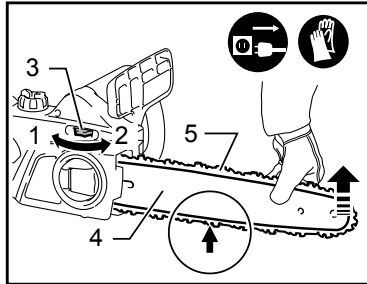

1. Loosen
2. Tighten
3. Adjusting dial
4. Guide bar
5. Saw chain

014678

3. Turn the adjusting dial to adjust the saw chain tension. Tighten the saw chain until the lower side of the saw chain fits in the guide bar rail (see circle).
4. Keep holding the guide bar lightly, tighten the sprocket cover after adjusting the chain tension. Make sure that the saw chain does not loose at lower side.
5. Press and return the lever to its original position.

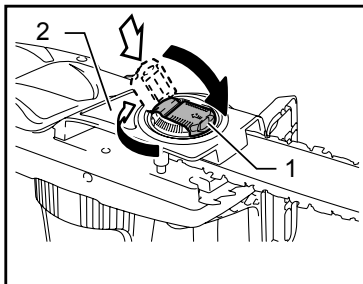

1. Lever
2. Sprocket cover

014343

Make sure the saw chain fits snugly against the lower side of the bar.

## ⚠CAUTION:

- Do not tighten the saw chain too much. Excessively high tension of saw chain may cause breakage of saw chain, wear of the guide bar and breakage of the adjusting dial.
- A chain which is too loose can jump off the bar, and therefore presents an accident risk.
- Carry out the procedure of installing or removing saw chain in a clean place free from sawdust and the like.

## Engaging extension cord

### ⚠CAUTION:

- Make sure that the extension cord is unplugged to the mains outlet.

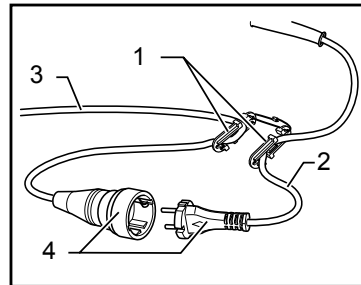

1. Cord hook
2. Tool's cord
3. Extension cord
4. Plug and socket (the shape may differ from country to country)

014359

When engaging the extension cord, secure it to the chain saw's cord with the cord hook. Attach the cord hook about 100 - 200 mm from the extension cord connector. This helps prevent unintentional disconnection.

## OPERATION

### Switch action

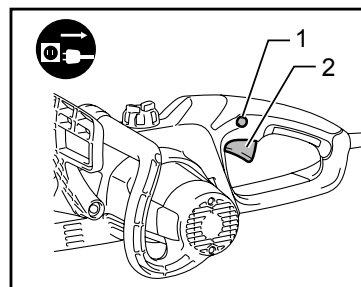

1. Lock-off button
2. Switch trigger

014320

### ⚠CAUTION:

- Always be sure that the tool is switched off and unplugged before checking function on the switch trigger.
- Before plugging in the tool, always check to see that the switch trigger actuates properly and returns to the "OFF" position when released.

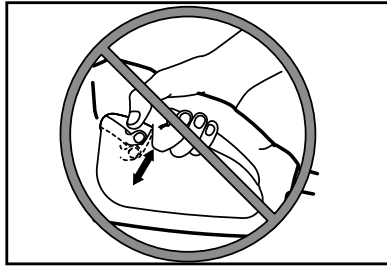

010373

**NOTE:**

- Do not turn on and off too often within a short time (five seconds or less). The temperature inside the tool will rise and may cause the tool damage. The time varies by atmosphere temperature and other conditions.

To prevent the switch trigger from being accidentally pulled, a lock-off button is provided.

To start the tool, depress the lock-off button and pull the switch trigger. Release the switch trigger to stop.

**Lubrication**

**CAUTION:**

- Always be sure that the tool is switched off and unplugged before lubricating the saw chain.

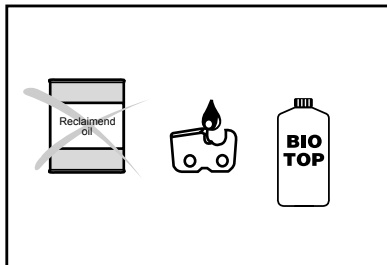

006921

Lubricate the saw chain and bar using biologically degradable saw chain oil with an adhesion agent. The adhesion agent in the saw chain oil prevents the oil from being thrown off the saw excessively quickly. Mineral oils must not be used, as they are harmful to the environment.

**CAUTION:**

- Prevent the oil from coming into contact with the skin and eyes. Contact with the eyes causes irritation. In the event of eye contact, flush the affected eye immediately with clear water, then consult a doctor at once.
- Never use waste oil. Waste oil contains carcinogenic substances. The contaminants in waste oil cause accelerated wear of the oil pump, the bar and the chain. Waste oil is harmful to the environment.

- When filling the chain saw with chain oil for the first time, or refilling the tank after it has been completely emptied, add oil up to the bottom edge of the filler neck. The oil delivery may otherwise be impaired.

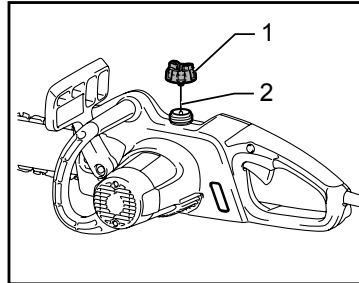

- Oil filler cap
- Strap

014330

To fill the oil, perform the following steps:

- Clean the area around the oil filler cap thoroughly to prevent any dirt from entering the oil tank.
- Unscrew the oil filler cap and add oil up to the lower edge of the filler neck.
- Screw the oil filler cap firmly back in place.
- Wipe away any spilt chain oil carefully.

**NOTE:**

- When the chain saw is used for the first time, it may take up to two minutes for the saw chain oil to begin its lubricating effect upon the saw mechanism. Run the saw without load until it does so (see "CHECKS").

**CHECKS**

Before starting work, carry out the following checks:

**Checking the chain tension**

**WARNING:**

- Always withdraw the mains plug before checking the chain tension, and wear safety gloves.

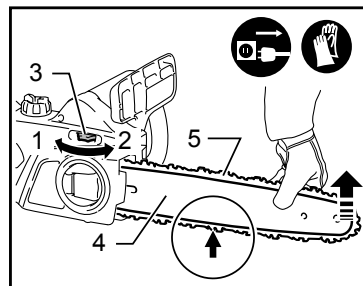

- Loosen
- Tighten
- Adjusting dial
- Guide bar
- Saw chain

014678

Make sure the saw chain fits snugly against the lower side of the bar (see circle).

Check the chain tension frequently, as new chains are subject to elongation.

Excessively high tension of saw chain may cause breakage of saw chain, wear of the guide bar and breakage of the adjusting dial.

A chain which is too loose can jump off the bar, and therefore presents an accident risk.

If the chain is too loose: Refer to the section titled "Adjusting saw chain tension" and adjust the saw chain tension again.

### Checking the switch action

#### ⚠CAUTION:

Before plugging in the tool, always check to see that the switch trigger actuates properly and returns to the "OFF" position when released.

To prevent the switch trigger from being accidentally pulled, a lock-off button is provided.

To start the tool, depress the lock-off button and pull the switch trigger. Release the switch trigger to stop.

Do not pull the switch trigger hard without depressing the lock-off button. This may cause switch breakage.

### Checking the chain brake

#### NOTE:

- If the chain saw fails to start, check whether the chain brake is released. To release the chain brake, pull the hand guard backwards firmly until you feel it engage.

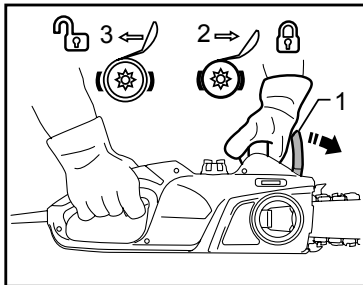

014331

1. Front hand guard
2. Lock
3. Unlock

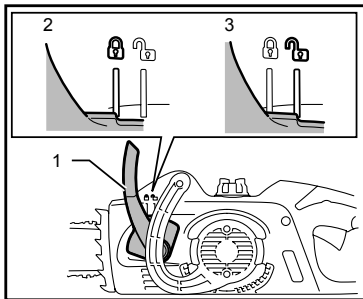

014438

Check the chain brake as follows:

1. Hold the chain saw with both hands when switching it on. Hold the rear handle with your right hand, the front handle with your left. Make sure that the bar and the chain do not contact with any object.
2. First press the lock-off button, then the switch trigger. The saw chain starts immediately.
3. Press the front hand guard forwards using the back of your hand. Make sure that the saw chain comes to an immediate standstill.

#### ⚠CAUTION:

- If the saw chain does not stop immediately, do not use the saw under any circumstances. Consult Makita authorized service centers.

### Checking the run-down brake

Switch on the chain saw.

Release the switch trigger completely. Make sure the saw chain comes to a standstill within a second.

#### ⚠CAUTION:

- If the saw chain does not stop immediately, do not use the saw under any circumstances. Consult Makita authorized service centers.

### Checking the chain oiler

Before starting work, check the oil level in the tank, and the oil delivery.

The oil level can be seen in the oil level sight shown in the figure.

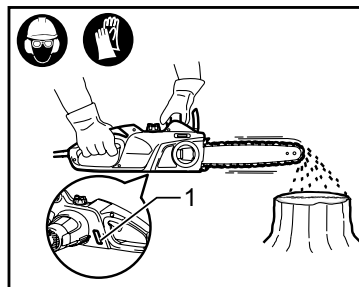

014332

1. Oil level sight

Check the oil delivery as follows:

Start the chain saw.

With the saw running, hold the saw chain approximately 15 cm above a tree trunk or the ground. If lubrication is adequate, the oil spray will produce a light oil trace.

Observe the wind direction, and do not expose yourself to the oil spray unnecessarily.

#### ⚠CAUTION:

- If an oil trace is not formed, do not use the saw. The lifespan of the chain will otherwise be reduced. Check the oil level. Clean the oil feed groove and the oil feed hole in the bar (refer to "MAINTENANCE").

### Adjusting the chain lubrication

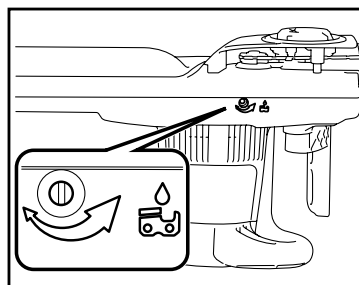

014341

You can adjust the oil pump feed rate with the adjusting screw.

**⚠CAUTION:**

- Always use a front handle and rear handle and firmly hold the tool by both front handle and rear handle during operations.
- Always secure the timber to be cut, otherwise the cut fragments may cause personal injury.

**WORKING WITH THE CHAIN SAW**

**Bucking**

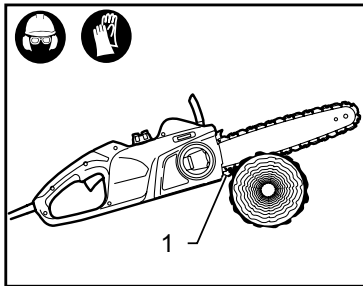

1. Spike bumper

014333

For bucking cuts, rest the spike bumper shown in the figure on the wood to be cut.

With the saw chain running, saw into the wood, using the rear handle to raise the saw and the front one to guide it. Use the spike bumper as a pivot.

Continue the cut by applying slight pressure to the front handle, easing the saw back slightly. Move the spike bumper further down the timber and raise the front handle again.

When making several cuts, switch the chain saw off between cuts.

**⚠CAUTION:**

- If the upper edge of the bar is used for cutting, the chain saw may be deflected in your direction if the chain becomes trapped. For this reason, cut with the lower edge, so that the saw will be deflected away from your body.

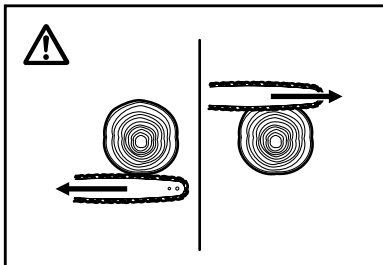

006914

Cut wood under tension on the pressure side (A) first. Then make the final cut on the tension side (B). This prevents the bar from becoming trapped.

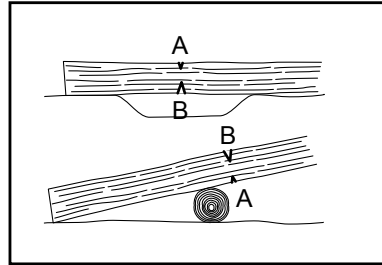

006915

**Limbing**

**⚠CAUTION:**

- Limbing may only be performed by trained persons. A hazard is presented by the risk of kickback.

When limbing, support the chain saw on the trunk if possible. Do not cut with the tip of the bar, as this presents a risk of kickback.

Pay particular attention to branches under tension. Do not cut unsupported branches from below.

Do not stand on the felled trunk when limbing.

**Burrowing and parallel-to-grain cuts**

**⚠CAUTION:**

- Burrowing and parallel-to-grain cuts may only be carried out by persons with special training. The possibility of kickback presents a risk of injury.

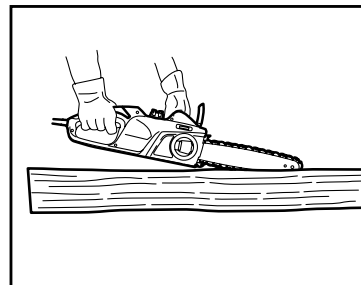

014334

Perform parallel-to-grain cuts at as shallow an angle as possible. Carry out the cut as carefully as possible, as the spike bumper cannot be used.

**Felling**

**⚠CAUTION:**

- Felling work may only be performed by trained persons. The work is hazardous.

Observe local regulations if you wish to fell a tree.



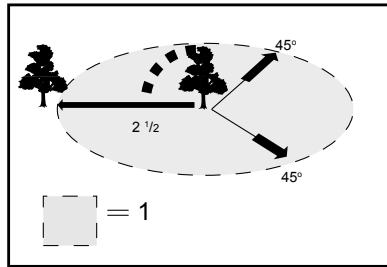

006917

### 1. Felling area

- Before starting felling work, ensure that:
  - (1) Only persons involved in the felling operation are in the vicinity;
  - (2) Any person involved has an unimpeded path of retreat through a range of approximately 45 ° either side of the felling axis. Consider the additional risk of tripping over electrical cables;
  - (3) The base of the trunk is free of foreign objects, roots and stumps;
  - (4) No persons or objects are present over a distance of 2 1/2 tree lengths in the direction in which the tree will fall.
- Consider the following with respect to each tree:
  - Direction of lean;
  - Loose or dry branches;
  - Height of the tree;
  - Natural overhang;
  - Whether or not the tree is rotten.
- Consider the wind speed and direction. Do not carry out felling work if the wind is gusting strongly.
- Trimming of root swellings: Begin with the largest swellings. Make the vertical cut first, then the horizontal cut.

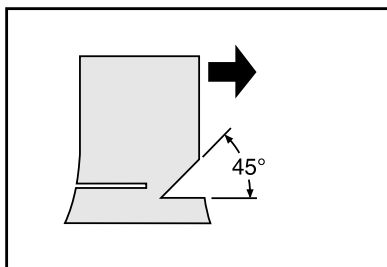

006918

- Cut a scarf: The scarf determines the direction in which the tree will fall, and guides it. It is made on the side towards which the tree is to fall. Cut the scarf as close to the ground as possible. First make the horizontal cut to a depth of 1/5 -1/3 of the trunk diameter. Do not make the scarf too large. Then make the diagonal cut.
- Cut any corrections to the scarf across its entire width.

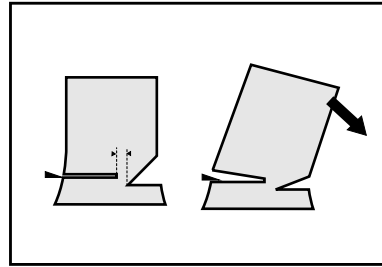

006923

- Make the back cut a little higher than the base cut of the scarf. The back cut must be exactly horizontal. Leave approximately 1/10 of the trunk diameter between the back cut and the scarf. The wood fibers in the uncut trunk portion act as a hinge. Do not cut right through the fibers under any circumstances, as the tree will otherwise fall unchecked. Insert wedges into the back cut in time.
- Only plastic or aluminum wedges may be used to keep the back cut open. The use of iron wedges is prohibited.
- Stand to the side of the falling tree. Keep an area clear to the rear of the falling tree up to an angle of 45 ° either side of the tree axis (refer to the " felling area " figure). Pay attention to falling branches.
- An escape path should be planned and cleared as necessary before cuts are started. The escape path should extend back and diagonally to the rear of the expected line of fall as illustrated in figure.

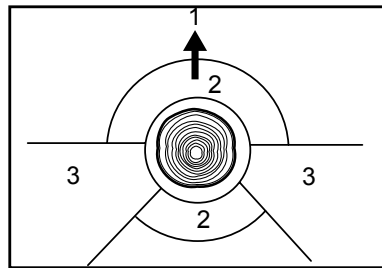

009202

1. Felling direction
2. Danger zone
3. Escape route

## MAINTENANCE

### ⚠CAUTION:

- Always be sure that the tool is switched off and unplugged before attempting to perform inspection or maintenance.
- Always wear gloves when performing any inspection or maintenance.
- Never use gasoline, benzene, thinner, alcohol or the like. Discoloration, deformation or cracks may result.

Carry out the maintenance work described below at regular intervals. Warranty claims will be accepted only if these operations have been performed regularly and properly.

Only maintenance work described in this instruction manual may be performed by the user. Any other work must be carried out by MAKITA authorized service centers.

### Cleaning the chain saw

Clean the saw regularly with a clean rag. The handles, in particular, must be kept free of oil.

### Checking the plastic housing

Carry out regular visual inspections of all parts of the housing. If any parts are damaged, have them repaired immediately and properly in MAKITA authorized service centers.

### Sharpening the saw chain

#### ⚠ CAUTION:

- Always withdraw the mains plug and wear safety gloves when performing work on the saw chain.

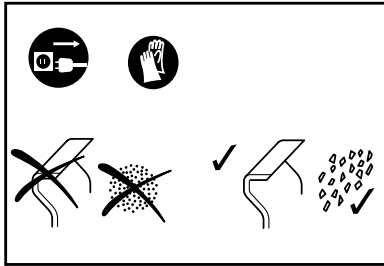

006924

#### Sharpen the saw chain when:

- Mealy sawdust is produced when damp wood is cut;
- The chain penetrates the wood with difficulty, even when heavy pressure is applied;
- The cutting edge is obviously damaged;
- The saw pulls to the left or right in the wood. The reason for this behavior is uneven sharpening of the saw chain, or damage to one side only.

#### Sharpen the saw chain frequently, but remove only a little material each time.

Two or three strokes with a file are usually sufficient for routine reshaping. When the saw chain has been reshaped several times, have it sharpened in MAKITA authorized service center.

#### Sharpening criteria:

- All cutter length must be equal. Cutters of differing length prevent the chain from running smoothly, and may cause the chain to break.
- Do not sharpen the chain once a minimum cutter length of 3 mm has been reached. A new chain must then be fitted.
- The chip thickness is determined by the distance between the depth gauge (round nose) and the cutting edge.

- The best cutting results are obtained with following distance between cutting edge and depth gauge.  
Chain blade 90PX: 0.5 mm  
Chain blade 91PX: 0.65 mm

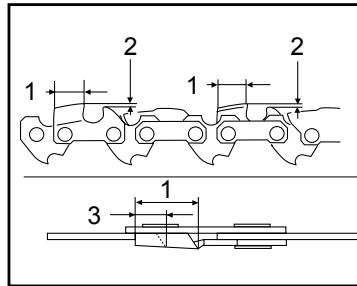

014335

#### ⚠ WARNING:

- An excessive distance increases the risk of kick-back.
- The sharpening angle of 30° must be the same on all cutters. Differences in angle cause the chain to run roughly and unevenly, accelerate wear, and lead to chain breaks.
- The side plate angle of the cutter is determined by the depth of penetration of the round file. If the specified file is used properly, the correct side plate angle is produced automatically.
- Side plate angle for each saw chain are as follows:  
Chain blade 90PX: 75°  
Chain blade 91PX: 80°

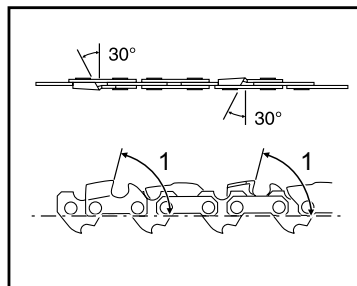

014338

- 1. Side plate angle

#### File and file guiding

- Use a special round file (optional accessory) for saw chains to sharpen the chain. Normal round files are not suitable.
- Diameter of the round file for each saw chain is as follows:  
Chain blade 90PX: 4.5 mm  
Chain blade 91PX: 4.0 mm
- The file should only engage the cutter on the forward stroke. Lift the file off the cutter on the return stroke.
- Sharpen the shortest cutter first. Then the length of this shortest cutter becomes the standard for all other cutters on the saw chain.

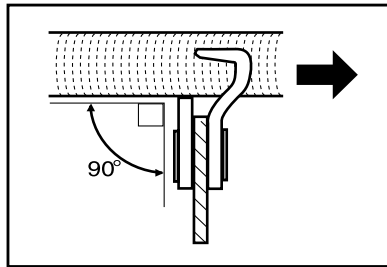

006927

- Guide the file as shown in the figure.
- The file can be guided more easily if a file holder (optional accessory) is employed. The file holder has markings for the correct sharpening angle of 30° (align the markings parallel to the saw chain) and limits the depth of penetration (to 4/5 of the file diameter).

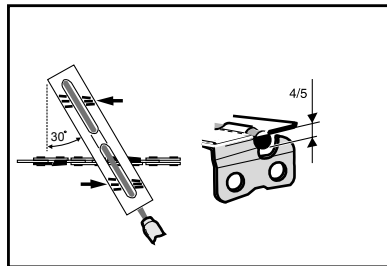

006928

- After sharpening the chain, check the height of the depth gauge using the chain gauge tool (optional accessory).

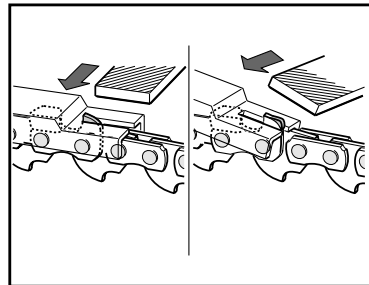

014344

- Remove any projecting material, however small, with a special flat file (optional accessory).
- Round off the front of the depth gauge again.

### Cleaning the guide bar and lubricating the return sprocket

#### ⚠ CAUTION:

- Always wear safety gloves for this task. Burrs present a risk of injury.

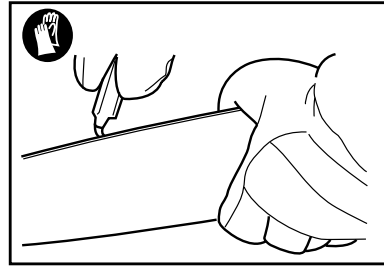

006930

Check the running surfaces of the bar regularly for damage. Clean using a suitable tool, and remove burrs if necessary.

If the chain saw receives frequent use, lubricate the return sprocket bearing at least once a week. Before adding new fresh grease, carefully clean the 2 mm hole on the tip of the guide bar, then force a small quantity of multi-purpose grease (optional accessory) into the hole.

### Cleaning the oil guide

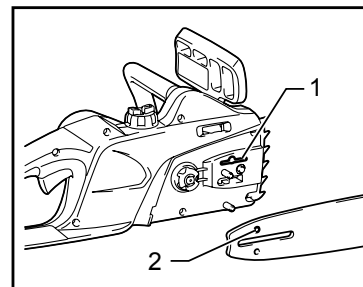

1. Oil guide groove
2. Oil feed hole

014357

- Clean the oil guide groove and the oil feed hole in the bar at regular intervals.

### New saw chains

Use two or three saw chains alternately, so that the saw chain, sprocket and running surfaces of the bar wear evenly.

Turn the bar over when changing the chain so that the bar groove wears evenly.

#### ⚠ CAUTION:

- Only use chains and bars which are approved for this model of saw (refer to "SPECIFICATIONS").

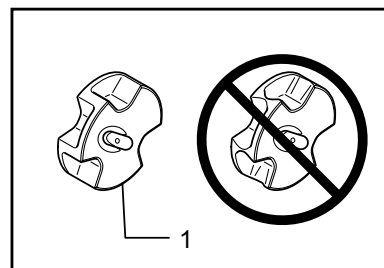

1. Sprocket

006932

Before fitting a new saw chain, check the condition of the sprocket.

---

**⚠ CAUTION:**

- A worn sprocket damages a new saw chain. Have the sprocket replaced in this case.

Always fit a new locking ring when replacing the sprocket.

**Maintaining the chain and run-down brakes**

The braking systems are very important safety features. Like any other component of the chain saw, they are subject to a certain degree of wear. They must be inspected regularly by MAKITA authorized service centers. This measure is for your own safety.

**Storing tool**

Biologically degradable saw chain oil can only be kept for a limited period. Beyond two years after manufacture, biological oils begin to acquire an adhesive quality, and cause damage to the oil pump and components in the lubricating system.

- Before taking the chain saw out of service for a longer period, empty the oil tank and fill it with a small quantity of engine oil (SAE 30).
- Run the chain saw briefly to flush all residue of the biological oil out of the tank, lubricating system and saw mechanism.

**NOTE:**

- When the chain saw is taken out of service, small quantities of chain oil leaks from it for some time afterwards. This is normal, and is not a sign of a fault.

Store the chain saw on a suitable surface.

Before returning the chain saw to service, fill up with fresh BIOTOP saw chain oil.

To maintain product SAFETY and RELIABILITY, repairs, carbon brush inspection and replacement, any other maintenance or adjustment should be performed by Makita Authorized Service Centers, always using Makita replacement parts.

## TROUBLE SHOOTING

Before asking for repairs, conduct your own inspection first. If you find a problem that is not explained in the manual, do not attempt to dismantle the tool. Instead, ask Makita Authorized Service Centers.

Malfunction status	Possible cause	Remedy
The chain saw does not start.	No power supply.	Connect to the power supply. Check the power supply.
	Cable defective.	Stop using the tool immediately, and ask your local authorized service center.
	Tool malfunction.	Stop using the tool immediately, and ask your local authorized service center.
Chain does not run.	Chain brake is engaged.	Release chain brake.
Insufficient performance.	Carbon brush worn down.	Ask your local authorized service center for repair.
No oil on the chain.	Oil tank is empty.	Fill the oil tank.
	Oil guide groove is dirty.	Clean the groove.
	Oil pump adjusting screw incorrectly adjusted.	Adjust the oil pump feed rate.
Chain does not stop even the chain brake is engaged.	Brake band worn down.	Stop using the tool immediately, and ask your local authorized service center.
The tool vibrates abnormally.	Loose guide bar or saw chain.	Adjust the guide bar and saw chain tension.
	Tool malfunction.	Stop using the tool immediately, and ask your local authorized service center.

014314

## OPTIONAL ACCESSORIES

### CAUTION:

- These accessories or attachments are recommended for use with your Makita tool specified in this manual. The use of any other accessories or attachments might present a risk of injury to persons. Only use accessory or attachment for its stated purpose.

If you need any assistance for more details regarding these accessories, ask your local Makita Service Center.

- Saw chain
- Guide bar cover
- Guide bar
- Chain gauge
- Round file 4.0 mm
- Round file 4.5 mm

- Flat file
- File holder with 4.0 mm file
- File holder with 4.5 mm file
- File handle
- Saw chain oil
- Multi-purpose grease
- Grease gun

### NOTE:

- Some items in the list may be included in the tool package as standard accessories. They may differ from country to country.

**Makita** Jan-Baptist Vinkstraat 2, 3070, Belgium  
**Makita Corporation** Anjo, Aichi, Japan

885254-224

[www.makita.com](http://www.makita.com)